

# LM5100/LM5101

## High Voltage High Side and Low Side Gate Driver

### General Description

The LM5100/LM5101 High Voltage Gate Drivers are designed to drive both the high side and the low side N-Channel MOSFETs in a synchronous buck or a half bridge configuration. The floating high-side driver is capable of operating with supply voltages up to 100V. The outputs are independently controlled with CMOS input thresholds (LM5100) or TTL input thresholds (LM5101). An integrated high voltage diode is provided to charge the high side gate drive bootstrap capacitor. A robust level shifter operates at high speed while consuming low power and providing clean level transitions from the control logic to the high side gate driver. Under-voltage lockout is provided on both the low side and the high side power rails. This device is available in the standard SOIC-8 pin and the LLP-10 pin packages.

### Features

- Drives both a high side and low side N-Channel MOSFET
- Independent high and low driver logic inputs (TTL for LM5101 or CMOS for LM5100)

- Bootstrap supply voltage range up to 118V DC
- Fast propagation times (25 ns typical)
- Drives 1000 pF load with 15 ns rise and fall times
- Excellent propagation delay matching (3 ns typical)
- Supply rail under-voltage lockouts
- Low power consumption
- Pin compatible with HIP2100/HIP2101

### Typical Applications

- Current Fed push-pull converters
- Half and Full Bridge power converters
- Synchronous buck converters
- Two switch forward power converters
- Forward with Active Clamp converters

### Package

- SOIC-8
- LLP-10 (4 mm x 4 mm)

### Simplified Block Diagram

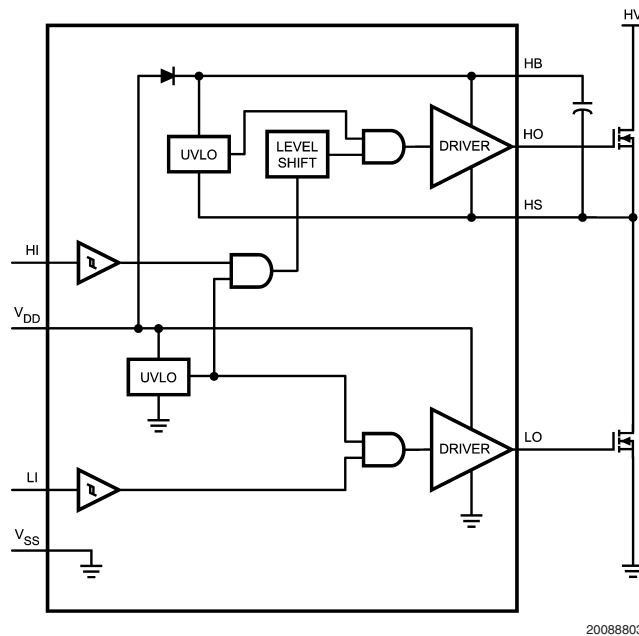

FIGURE 1.

## Connection Diagrams

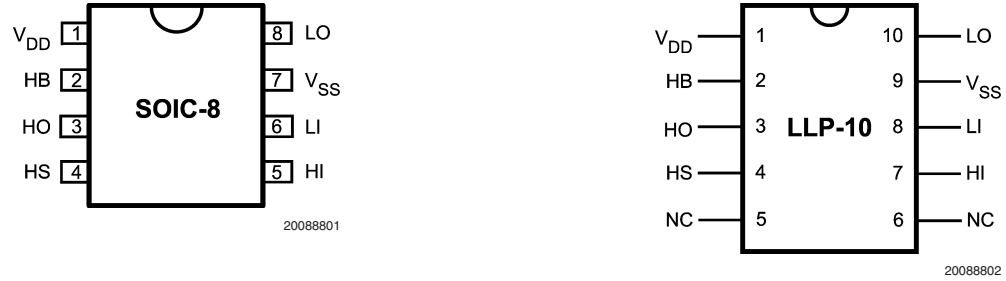

FIGURE 2.

## Ordering Information

Ordering Number	Package Type	NSC Package Drawing	Supplied As
LM5100/01M	SOIC-8	M08A	Shipped in anti static rails
LM5100/01MX	SOIC-8	M08A	2500 shipped as Tape & Reel
LM5100/01SD	LLP-10	SDC10A	1000 shipped as Tape & Reel
LM5100/01SDX	LLP-10	SDC10A	4500 shipped as Tape & Reel

## Pin Description

Pin #		Name	Description	Application Information
SO-8	LLP-10			
1	1	$V_{DD}$	Positive gate drive supply	Locally decouple to $V_{SS}$ using low ESR/ESL capacitor located as close to IC as possible.
2	2	HB	High side gate driver bootstrap rail	Connect the positive terminal of the bootstrap capacitor to HB and the negative terminal to HS. The Bootstrap capacitor should be place as close to IC as possible.
3	3	HO	High side gate driver output	Connect to gate of high side MOSFET with a short low inductance path.
4	4	HS	High side MOSFET source connection	Connect to bootstrap capacitor negative terminal and the source of the high side MOSFET.
5	7	HI	High side driver control input	The LM5100 inputs have CMOS type thresholds. The LM5101 inputs have TTL type thresholds. Unused inputs should be tied to ground and not left open.
6	8	LI	Low side driver control input	The LM5100 inputs have CMOS type thresholds. The LM5101 inputs have TTL type thresholds. Unused inputs should be tied to ground and not left open.
7	9	$V_{SS}$	Ground return	All signals are referenced to this ground.
8	10	LO	Low side gate driver output	Connect to the gate of the low side MOSFET with a short low inductance path.

**Note:** For LLP-10 package, it is recommended that the exposed pad on the bottom of the LM5100 / LM5101 be soldered to ground plane on the PC board, and the ground plane should extend out from beneath the IC to help dissipate the heat. Pins 5 and 6 have no connection.

## Absolute Maximum Ratings (Note 1)

If Military/Aerospace specified devices are required, please contact the National Semiconductor Sales Office/Distributors for availability and specifications.

$V_{DD}$ to $V_{SS}$	-0.3V to +18V
$V_{HB}$ to $V_{HS}$	-0.3V to +18V
LI or HI Inputs	-0.3V to $V_{DD} + 0.3V$
LO Output	-0.3V to $V_{DD} + 0.3V$
HO Output	$V_{HS} - 0.3V$ to $V_{HB} + 0.3V$
$V_{HS}$ to $V_{SS}$	-1V to +100V
$V_{HB}$ to $V_{SS}$	118V
Junction Temperature	+150°C

Storage Temperature Range -55°C to +150°C

ESD Rating HBM (Note 2) 2 kV

## Recommended Operating Conditions

$V_{DD}$	+9V to +14V
HS	-1V to 100V
HB	$V_{HS} + 8V$ to $V_{HS} + 14V$
HS Slew Rate	< 50 V/ns
Junction Temperature	-40°C to +125°C

## Electrical Characteristics

Specifications in standard typeface are for  $T_J = +25^\circ\text{C}$ , and those in **boldface type** apply over the full **operating junction temperature range**. Unless otherwise specified,  $V_{DD} = V_{HB} = 12V$ ,  $V_{SS} = V_{HS} = 0V$ , No Load on LO or HO.

Symbol	Parameter	Conditions	Min	Typ	Max	Units
<b>SUPPLY CURRENTS</b>						
$I_{DD}$	$V_{DD}$ Quiescent Current	LI = HI = 0V (LM5100)		0.1	<b>0.2</b>	mA
		LI = HI = 0V (LM5101)		0.25	<b>0.4</b>	
$I_{DDO}$	$V_{DD}$ Operating Current	f = 500 kHz		1.5	<b>3</b>	mA
$I_{HB}$	Total HB Quiescent Current	LI = HI = 0V		0.06	<b>0.2</b>	mA
$I_{HBO}$	Total HB Operating Current	f = 500 kHz		1.3	<b>3</b>	mA
$I_{HBS}$	HB to $V_{SS}$ Current, Quiescent	$V_{HS} = V_{HB} = 100V$		0.05	<b>10</b>	$\mu\text{A}$
$I_{HBSO}$	HB to $V_{SS}$ Current, Operating	f = 500 kHz		0.08		mA
<b>INPUT PINS</b>						
$V_{IL}$	Low Level Input Voltage Threshold (LM5100)		<b>3</b>	5.0		V
$V_{IL}$	Low Level Input Voltage Threshold (LM5101)		<b>0.8</b>	1.8		V
$V_{IH}$	High Level Input Voltage Threshold (LM5100)			5.5	<b>8</b>	V
$V_{IH}$	High Level Input Voltage Threshold (LM5101)			1.8	<b>2.2</b>	V
$V_{IHYS}$	Input Voltage Hysteresis (LM5100)			0.5		V
$R_I$	Input Pulldown Resistance		<b>100</b>	200	<b>500</b>	k $\Omega$
<b>UNDER VOLTAGE PROTECTION</b>						
$V_{DDR}$	$V_{DD}$ Rising Threshold		<b>6.0</b>	6.9	<b>7.4</b>	V
$V_{DDH}$	$V_{DD}$ Threshold Hysteresis			0.5		V
$V_{HBR}$	HB Rising Threshold		<b>5.7</b>	6.6	<b>7.1</b>	V
$V_{HBH}$	HB Threshold Hysteresis			0.4		V
<b>BOOT STRAP DIODE</b>						
$V_{DL}$	Low-Current Forward Voltage	$I_{VDD-HB} = 100 \mu\text{A}$		0.6	<b>0.9</b>	V
$V_{DH}$	High-Current Forward Voltage	$I_{VDD-HB} = 100 \text{mA}$		0.85	<b>1.1</b>	V
$R_D$	Dynamic Resistance	$I_{VDD-HB} = 100 \text{mA}$		0.8	<b>1.5</b>	$\Omega$
<b>LO GATE DRIVER</b>						
$V_{OLL}$	Low-Level Output Voltage	$I_{LO} = 100 \text{mA}$		0.23	<b>0.4</b>	V
$V_{OHL}$	High-Level Output Voltage	$I_{LO} = -100 \text{mA}$ , $V_{OHL} = V_{DD} - V_{LO}$		0.35	<b>0.55</b>	V
$I_{OHL}$	Peak Pullup Current	$V_{LO} = 0V$		1.6		A
$I_{OLL}$	Peak Pulldown Current	$V_{LO} = 12V$		1.8		A
<b>HO GATE DRIVER</b>						
$V_{OLH}$	Low-Level Output Voltage	$I_{HO} = 100 \text{mA}$		0.23	<b>0.4</b>	V

## Electrical Characteristics (Continued)

Specifications in standard typeface are for  $T_J = +25^\circ\text{C}$ , and those in **boldface type** apply over the full **operating junction temperature range**. Unless otherwise specified,  $V_{DD} = V_{HB} = 12\text{V}$ ,  $V_{SS} = V_{HS} = 0\text{V}$ , No Load on LO or HO.

Symbol	Parameter	Conditions	Min	Typ	Max	Units
<b>HO GATE DRIVER</b>						
$V_{OHH}$	High-Level Output Voltage	$I_{HO} = -100\text{ mA}$ $V_{OHH} = V_{HB} - V_{HO}$		0.35	<b>0.55</b>	V
$I_{OHH}$	Peak Pullup Current	$V_{HO} = 0\text{V}$		1.6		A
$I_{OLH}$	Peak Pulldown Current	$V_{HO} = 12\text{V}$		1.8		A
<b>THERMAL RESISTANCE</b>						
$\theta_{JA}$	Junction to Ambient	SOIC-8		170		$^\circ\text{C/W}$
		LLP-10 (Note 3)		40		

## Switching Characteristics

Specifications in standard typeface are for  $T_J = +25^\circ\text{C}$ , and those in **boldface type** apply over the full **operating junction temperature range**. Unless otherwise specified,  $V_{DD} = V_{HB} = 12\text{V}$ ,  $V_{SS} = V_{HS} = 0\text{V}$ , No Load on LO or HO.

Symbol	Parameter	Conditions	Min	Typ	Max	Units
<b>LM5100</b>						
$t_{LPHL}$	Lower Turn-Off Propagation Delay (LI Falling to LO Falling)			24	<b>45</b>	ns
$t_{HPHL}$	Upper Turn-Off Propagation Delay (HI Falling to HO Falling)			24	<b>45</b>	ns
$t_{LPLH}$	Lower Turn-On Propagation Delay (LI Rising to LO Rising)			24	<b>45</b>	ns
$t_{HPLH}$	Upper Turn-On Propagation Delay (HI Rising to HO Rising)			24	<b>45</b>	ns
$t_{MON}$	Delay Matching: Lower Turn-On and Upper Turn-Off			2	<b>10</b>	ns
$t_{MOFF}$	Delay Matching: Lower Turn-Off and Upper Turn-On			2	<b>10</b>	ns
$t_{RC}, t_{FC}$	Either Output Rise/Fall Time	$C_L = 1000\text{ pF}$		15		ns
$t_R, t_F$	Either Output Rise/Fall Time (3V to 9V)	$C_L = 0.1\text{ }\mu\text{F}$		0.6		$\mu\text{s}$
$t_{PW}$	Minimum Input Pulse Width that Changes the Output			50		ns
$t_{BS}$	Bootstrap Diode Turn-Off Time	$I_F = 20\text{ mA}$ , $I_R = 200\text{ mA}$		50		ns
<b>LM5101</b>						
$t_{LPHL}$	Lower Turn-Off Propagation Delay (LI Falling to LO Falling)			25	<b>56</b>	ns
$t_{HPHL}$	Upper Turn-Off Propagation Delay (HI Falling to HO Falling)			25	<b>56</b>	ns
$t_{LPLH}$	Lower Turn-On Propagation Delay (LI Rising to LO Rising)			25	<b>56</b>	ns
$t_{HPLH}$	Upper Turn-On Propagation Delay (HI Rising to HO Rising)			25	<b>56</b>	ns
$t_{MON}$	Delay Matching: Lower Turn-On and Upper Turn-Off			2	<b>10</b>	ns
$t_{MOFF}$	Delay Matching: Lower Turn-Off and Upper Turn-On			2	<b>10</b>	ns
$t_{RC}, t_{FC}$	Either Output Rise/Fall Time	$C_L = 1000\text{ pF}$		15		ns
$t_R, t_F$	Either Output Rise/Fall Time (3V to 9V)	$C_L = 0.1\text{ }\mu\text{F}$		0.6		$\mu\text{s}$

## Switching Characteristics (Continued)

Specifications in standard typeface are for  $T_J = +25^\circ\text{C}$ , and those in **boldface type** apply over the full **operating junction temperature range**. Unless otherwise specified,  $V_{DD} = V_{HB} = 12\text{V}$ ,  $V_{SS} = V_{HS} = 0\text{V}$ , No Load on LO or HO.

Symbol	Parameter	Conditions	Min	Typ	Max	Units
<b>LM5101</b>						
$t_{PW}$	Minimum Input Pulse Width that Changes the Output			50		ns
$t_{BS}$	Bootstrap Diode Turn-Off Time	$I_F = 20\text{ mA}$ , $I_R = 200\text{ mA}$		50		ns

**Note 1:** Absolute Maximum Ratings indicate limits beyond which damage to the component may occur. Operating Ratings are conditions under which operation of the device is guaranteed. Operating Ratings do not imply guaranteed performance limits. For guaranteed performance limits and associated test conditions, see the Electrical Characteristics tables.

**Note 2:** The human body model is a 100 pF capacitor discharged through a 1.5k $\Omega$  resistor into each pin. 2 kV for all pins except Pin 2, Pin 3 and Pin 4 which are rated at 500V.

**Note 3:** 4 layer board with Cu finished thickness 1.5/1/1/1.5 oz. Maximum die size used. 5x body length of Cu trace on PCB top. 50 x 50mm ground and power planes embedded in PCB. See Application Note AN-1187.

**Note 4:** Min and Max limits are 100% production tested at 25°C. Limits over the operating temperature range are guaranteed through correlation using Statistical Quality Control (SQC) methods. Limits are used to calculate National's Average Outgoing Quality Level (AOQL).

**Note 5:** The  $\theta_{JA}$  is not a given constant for the package and depends on the printed circuit board design and the operating environment.

# Typical performance Characteristics

LM5100  $I_{DD}$  vs Frequency

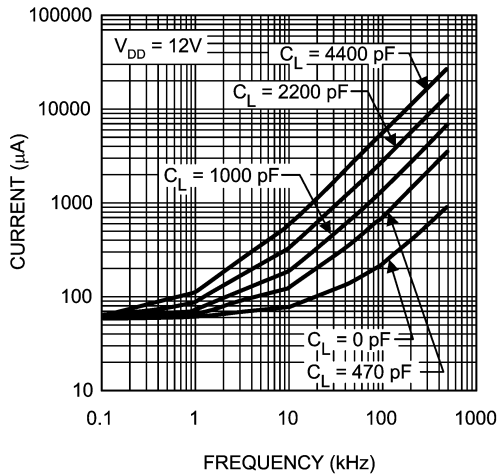

20088809

LM5101  $I_{DD}$  vs Frequency

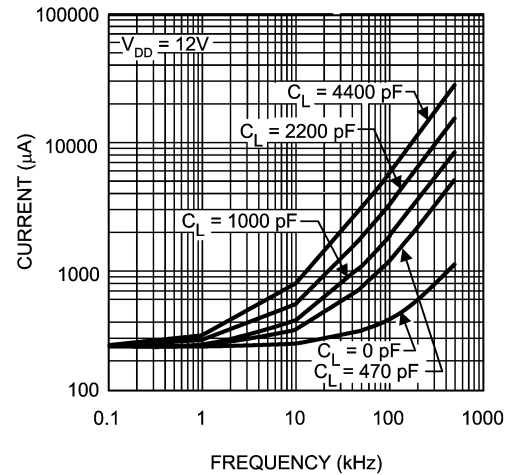

20088810

LM5100/LM5101 Operating Current vs Temperature

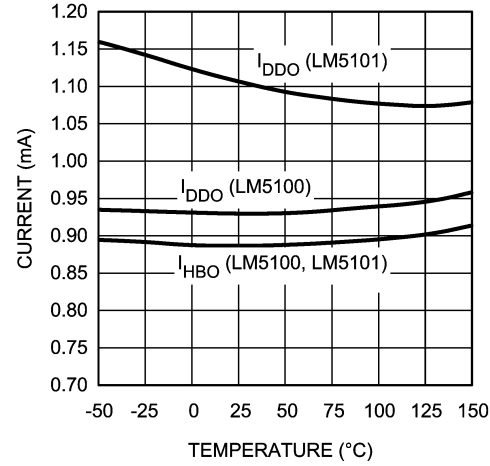

20088811

IHB vs Frequency

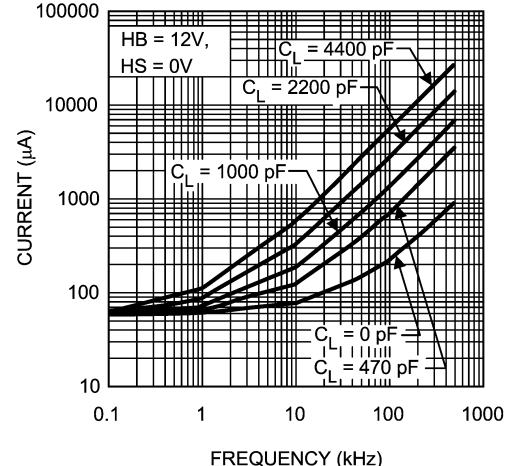

20088814

Quiescent Current vs Supply Voltage

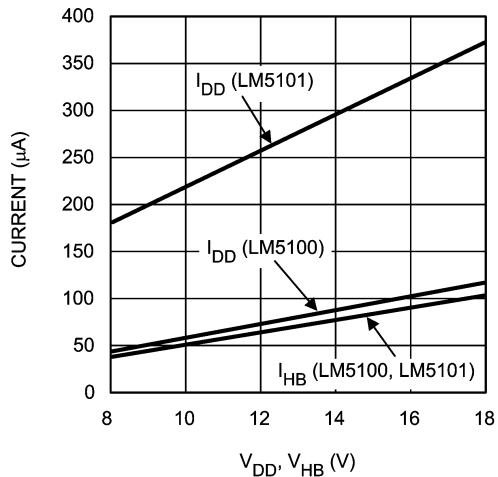

20088818

LM5100/LM5101 Quiescent Current vs Temperature

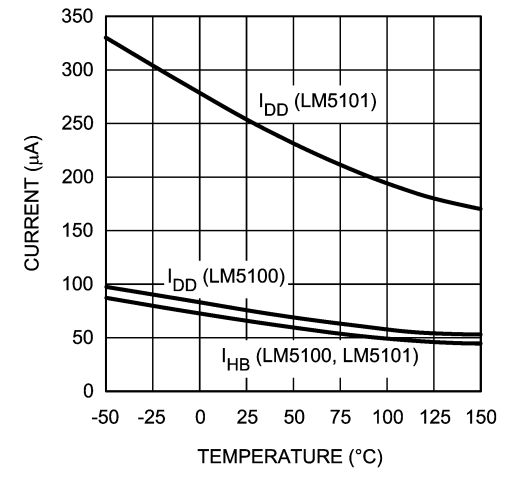

20088819

Typical performance Characteristics (Continued)

Undervoltage Rising Thresholds vs Temperature

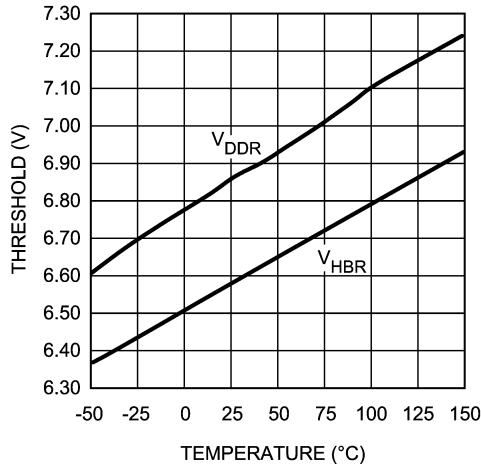

20088822

LM5100 Undervoltage Threshold Hysteresis vs Temperature

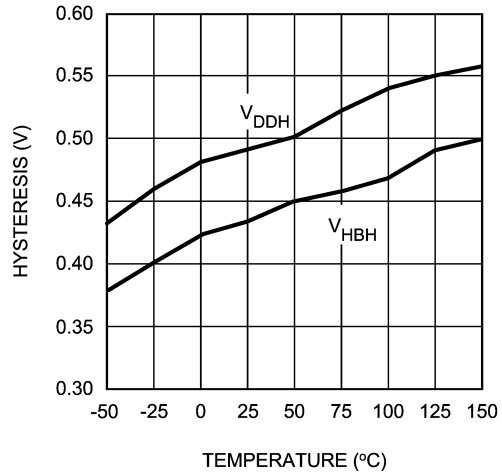

20088817

Bootstrap Diode Forward Voltage

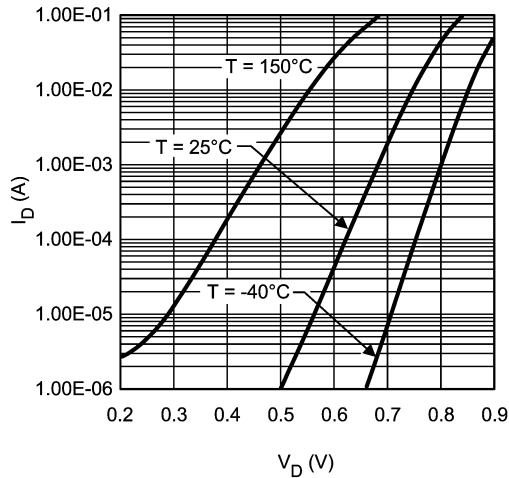

20088815

HO and LO Peak Output Current vs Output Voltage

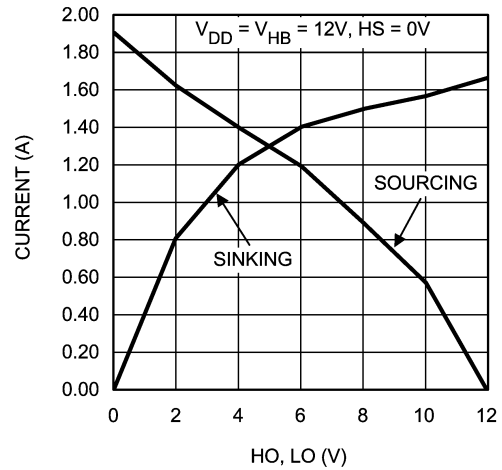

20088816

LO and HO Gate Drive—High Level Output Voltage vs Temperature

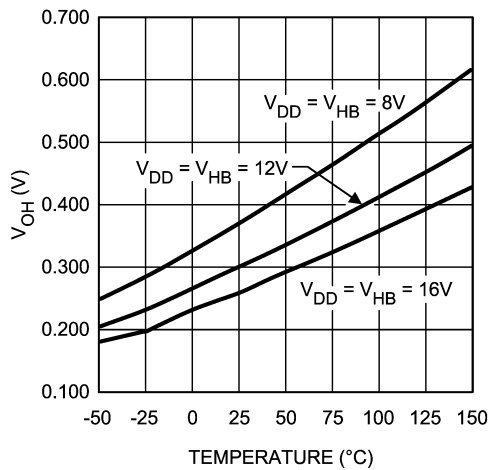

20088820

LO and HO Gate Drive—Low Level Output Voltage vs Temperature

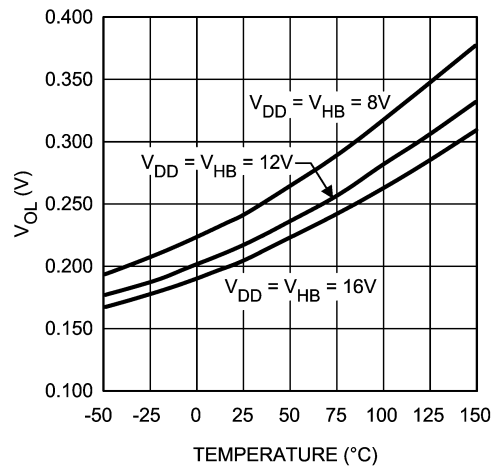

20088821

# Typical performance Characteristics (Continued)

LM5100 Propagation Delay vs Temperature

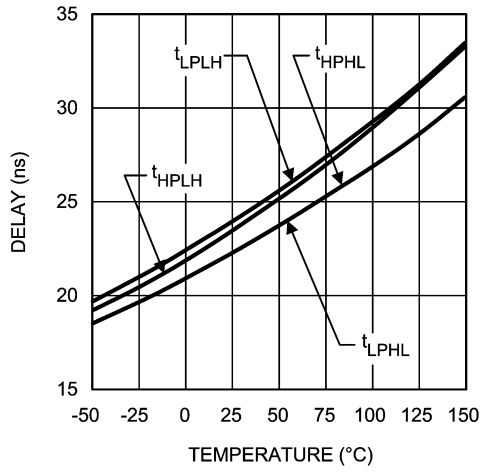

LM5101 Propagation Delay vs Temperature

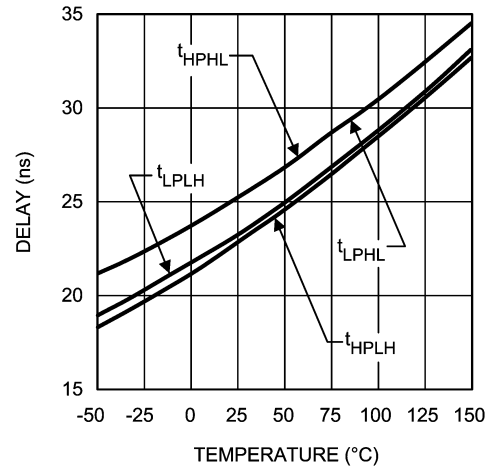



## Timing Diagram

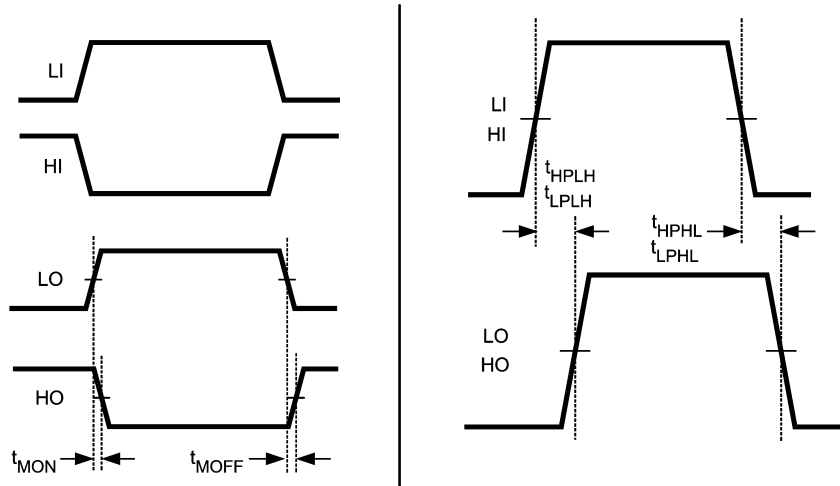

20088804

FIGURE 3.

## Layout Considerations

The optimum performance of high and low side gate drivers cannot be achieved without taking due considerations during circuit board layout. Following points are emphasized.

1. A low ESR / ESL capacitor must be connected close to the IC, and between  $V_{DD}$  and  $V_{SS}$  pins and between HB and HS pins to support high peak currents being drawn from VDD during turn-on of the external MOSFET.
2. To prevent large voltage transients at the drain of the top MOSFET, a low ESR electrolytic capacitor must be connected between MOSFET drain and ground ( $V_{SS}$ ).
3. In order to avoid large negative transients on the switch node (HS) pin, the parasitic inductances in the source of top MOSFET and in the drain of the bottom MOSFET (synchronous rectifier) must be minimized.
4. Grounding Considerations:
  - a) The first priority in designing grounding connections is to confine the high peak currents from charging and discharging the MOSFET gate in a minimal physical area. This will decrease the loop inductance and minimize noise issues on the gate terminal of the MOSFET. The MOSFETs should be placed as close as possible to the gate driver.
  - b) The second high current path includes the bootstrap capacitor, the bootstrap diode, the local ground referenced bypass capacitor and low side MOSFET body diode. The bootstrap capacitor is recharged on the cycle-by-cycle basis through the bootstrap diode from the ground referenced  $V_{DD}$  bypass capacitor. The recharging occurs in a short time interval and involves high peak current. Minimizing this loop length and area on the circuit board is important to ensure reliable operation.

losses are related to the switching frequency ( $f$ ), output load capacitance on LO and HO ( $C_L$ ), and supply voltage ( $V_{DD}$ ) and can be roughly calculated as:

$$P_{DGATES} = 2 \cdot f \cdot C_L \cdot V_{DD}^2$$

There are some additional losses in the gate drivers due to the internal CMOS stages used to buffer the LO and HO outputs. The following plot shows the measured gate driver power dissipation versus frequency and load capacitance. At higher frequencies and load capacitance values, the power dissipation is dominated by the power losses driving the output loads and agrees well with the above equation. This plot can be used to approximate the power losses due to the gate drivers.

Gate Driver Power Dissipation (LO + HO)  
 $V_{CC} = 12V$ , Neglecting Diode Losses

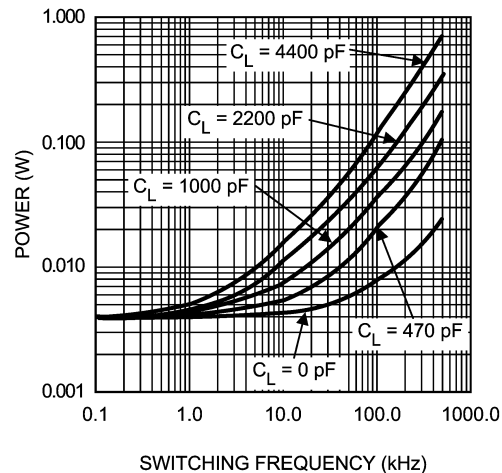

20088805

## Power Dissipation Considerations

The total IC power dissipation is the sum of the gate driver losses and the bootstrap diode losses. The gate driver

## Power Dissipation Considerations

(Continued)

The bootstrap diode power loss is the sum of the forward bias power loss that occurs while charging the bootstrap capacitor and the reverse bias power loss that occurs during reverse recovery. Since each of these events happens once per cycle, the diode power loss is proportional to frequency. Larger capacitive loads require more current to recharge the bootstrap capacitor resulting in more losses. Higher input voltages ( $V_{IN}$ ) to the half bridge result in higher reverse recovery losses. The following plot was generated based on calculations and lab measurements of the diode recovery time and current under several operating conditions. This can be useful for approximating the diode power dissipation.

Diode Power Dissipation  $V_{IN} = 80V$

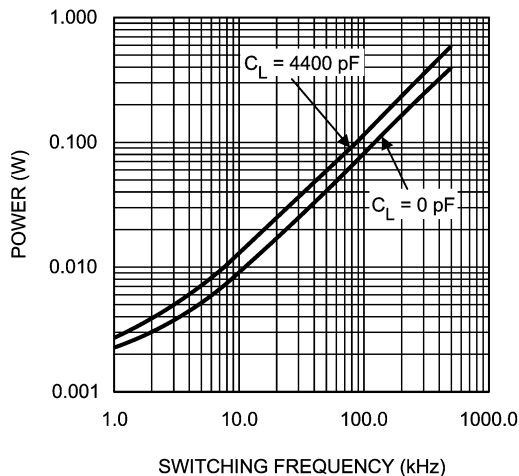

20088806

Diode Power Dissipation  $V_{IN} = 40V$

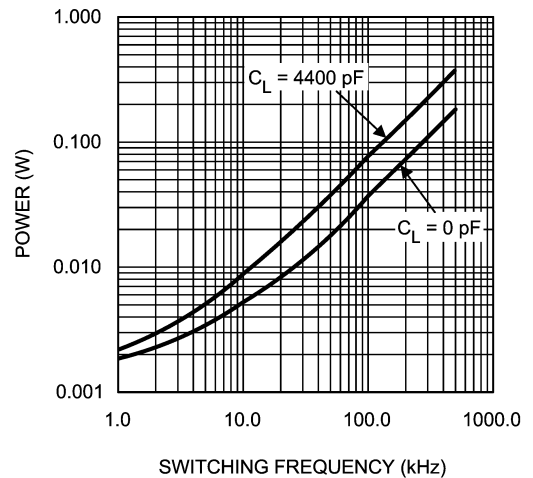

20088807

The total IC power dissipation can be estimated from the previous plots by summing the gate drive losses with the bootstrap diode losses for the intended application. Because the diode losses can be significant, an external diode placed in parallel (refer to Figure 4) with the internal bootstrap diode can be helpful in removing power from the IC. For this to be effective, the external diode must be placed close to the IC to minimize series inductance and have a significantly lower forward voltage drop than the internal diode.

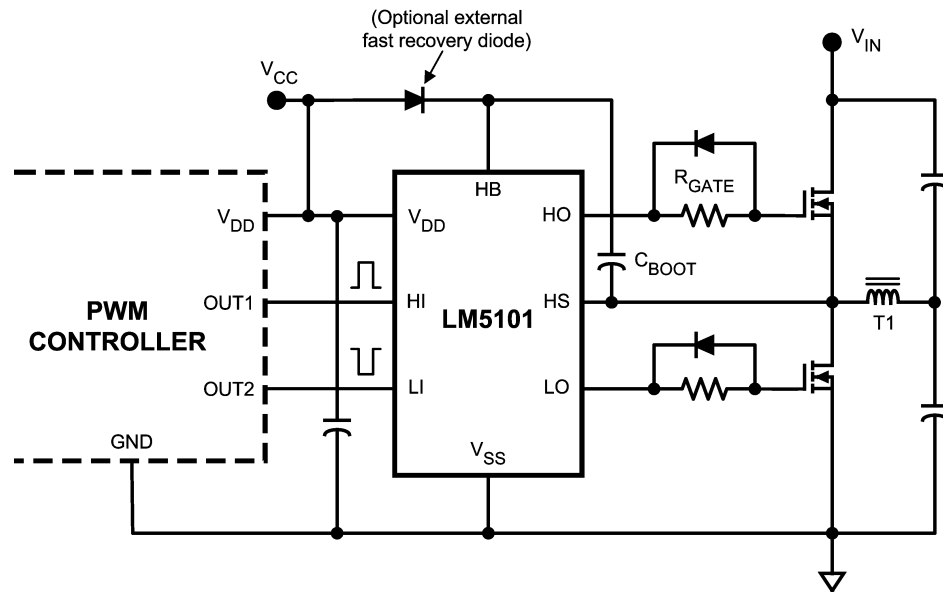

20088808

FIGURE 4. LM5101 Driving MOSFETs Connected in Half-Bridge Configuration

**Physical Dimensions** inches (millimeters) unless otherwise noted

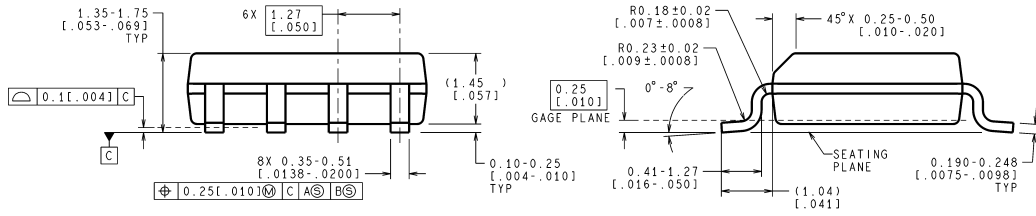
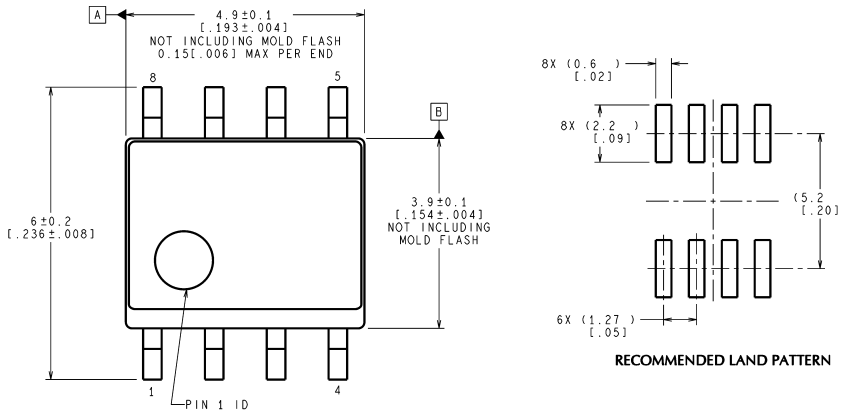

CONTROLLING DIMENSION IS MILLIMETER  
VALUES IN [ ] ARE INCHES  
DIMENSIONS IN ( ) FOR REFERENCE ONLY

M08A (Rev K)

Controlling dimension is inch. Values in [ ] are millimeters.

Notes: Unless otherwise specified.

1. Standard lead finish to be 200 microinches/5.08 micrometers minimum lead/tin (solder) on copper.
2. Dimension does not include mold flash.
3. Reference JEDEC registration MS-012, Variation AA, dated May 1990.

**SOIC-8 Outline Drawing  
NS Package Number M08A**

**Physical Dimensions** inches (millimeters) unless otherwise noted (Continued)

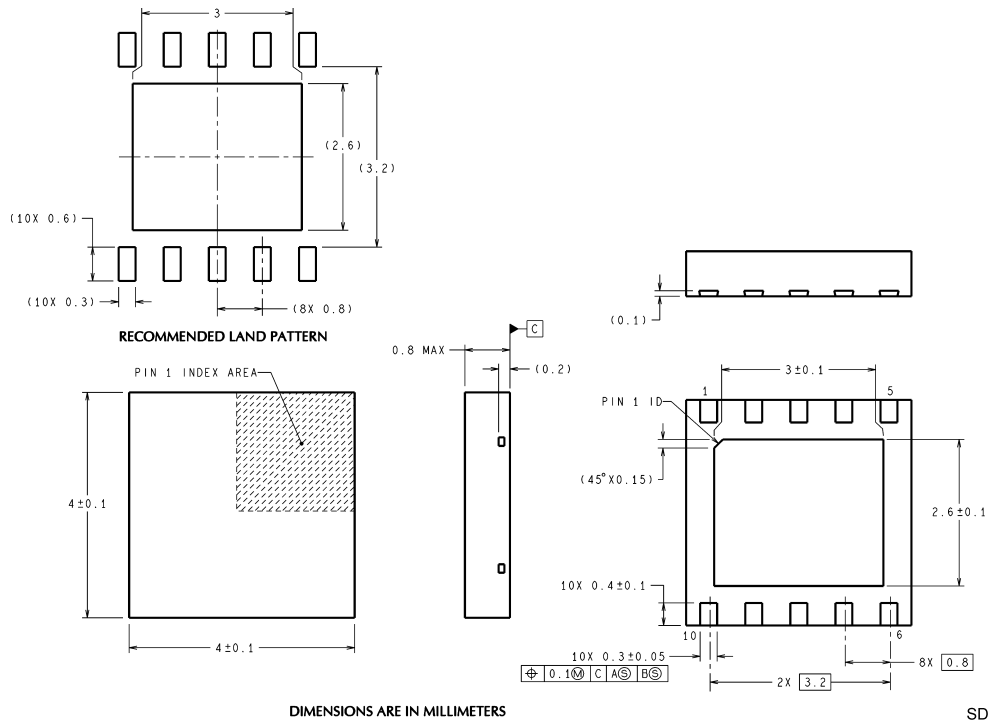

DIMENSIONS ARE IN MILLIMETERS

SDC10A (Rev A)

Notes: Unless otherwise specified.

1. For solder thickness and composition, see "Solder Information" in the packaging section of the National Semiconductor web page ([www.national.com](http://www.national.com)).
2. Maximum allowable metal burr on lead tips at the package edges is 76 microns.
3. No JEDEC registration as of May 2003.

**LLP-10 Outline Drawing  
NS Package Number SDC10A**

National does not assume any responsibility for use of any circuitry described, no circuit patent licenses are implied and National reserves the right at any time without notice to change said circuitry and specifications.

For the most current product information visit us at [www.national.com](http://www.national.com).

**LIFE SUPPORT POLICY**

NATIONAL'S PRODUCTS ARE NOT AUTHORIZED FOR USE AS CRITICAL COMPONENTS IN LIFE SUPPORT DEVICES OR SYSTEMS WITHOUT THE EXPRESS WRITTEN APPROVAL OF THE PRESIDENT AND GENERAL COUNSEL OF NATIONAL SEMICONDUCTOR CORPORATION. As used herein:

1. Life support devices or systems are devices or systems which, (a) are intended for surgical implant into the body, or (b) support or sustain life, and whose failure to perform when properly used in accordance with instructions for use provided in the labeling, can be reasonably expected to result in a significant injury to the user.
2. A critical component is any component of a life support device or system whose failure to perform can be reasonably expected to cause the failure of the life support device or system, or to affect its safety or effectiveness.

**BANNED SUBSTANCE COMPLIANCE**

National Semiconductor manufactures products and uses packing materials that meet the provisions of the Customer Products Stewardship Specification (CSP-9-111C2) and the Banned Substances and Materials of Interest Specification (CSP-9-111S2) and contain no "Banned Substances" as defined in CSP-9-111S2.

 **National Semiconductor**  
Americas Customer  
Support Center  
Email: [new.feedback@nsc.com](mailto:new.feedback@nsc.com)  
Tel: 1-800-272-9959

**National Semiconductor**  
Europe Customer Support Center  
Fax: +49 (0) 180-530 85 86  
Email: [europe.support@nsc.com](mailto:europe.support@nsc.com)  
Deutsch Tel: +49 (0) 69 9508 6208  
English Tel: +44 (0) 870 24 0 2171  
Français Tel: +33 (0) 1 41 91 8790

**National Semiconductor**  
Asia Pacific Customer  
Support Center  
Email: [ap.support@nsc.com](mailto:ap.support@nsc.com)

**National Semiconductor**  
Japan Customer Support Center  
Fax: 81-3-5639-7507  
Email: [jpn.feedback@nsc.com](mailto:jpn.feedback@nsc.com)  
Tel: 81-3-5639-7560